

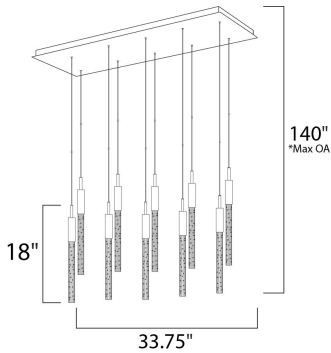

PRODUCT DESCRIPTION

Slender beveled cut rods of bubble glass, illuminated by high power LED modules, suspend in an array of fashionable configurations. Available in Black Chrome with Clear bubble glass and Anodized Bronze with Champagne bubble glass.



*max overall height



MEASUREMENTS

DIMENSION : 33.75" L x 11" W x 18" H
 MAX OAH : 140" OAH
 HANGING WEIGHT : 24.2 lb

LAMPING

INPUT VOLTAGE : 120V
 LUMENS : 5,250 Rated (2,500 Del.)
 BULB : 1 x 7.5W LED PCB Integrated , 75W Total
 BULB INCLUDED : (Integrated)
 DIMMABLE : Triac CL
 CRI : 90 CRI
 COLOR_TEMP : 3000K

FINISHES OPTION

-  Anodized Bronze
-  Black Chrome

GLASS

Bubble 91

MATERIAL

Steel

RATINGS

cETLus
 Dry Location



ADDITIONAL

ADJUSTABLE
 RATED LIFE 35000 Hours
 OPERATING TEMPERATURE:
 -20°C (-4°F), 40°C (104°F)

Always consult a qualified electrician before installing any lighting product.



WESTERN DISTRIBUTION CENTER (HEADQUARTER)
 253 NORTH VINELAND AVE | CITY OF INDUSTRY, CA 91746
EASTERN DISTRIBUTION CENTER
 4200 SHIRLEY DR. | ATLANTA, GA 30336
 P. 626.956.4200 | F. 626.956.4225 | et2online.com