

# Contemporary Lighting

**PRODUCT NAME:** Quartz  
**ITEM NUMBER:** E31241-20

**Please consult your electrician for hanging fixture and wiring.**

**The fixture is designed to with a standard Triac forward phase dimmer. Dimming levels will vary by dimmer.**

**Below is a list of recommended dimmers:**

**Lutron MACL-153M  
Lutron DVL-153P  
Lutron SCL-153P  
Leviton IPL06-10Z  
Leviton 6674-POW**

**Due to inrush current wattage should not exceed 150 watts of product for a 600 watt dimmer.**

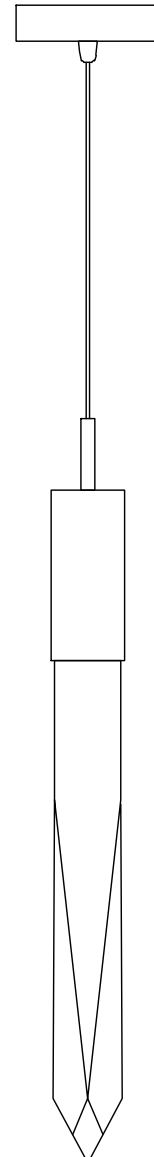

**AC LED 1 x 6W Bulb**

**MADE IN CHINA**

**Page 1 of (2)**

**IMPORTANT: Turn off the power at the main fuse or circuit breaker box before starting installation**



**A**  
Mounting Bracket



**B**  
Anchors  
2PCS



**C**  
Canopy Screws  
2PCS

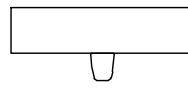

**D**  
Canopy



**E**  
Cup

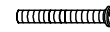

**F**  
Screws



**G**  
Glass

**Locate all hardware & components before discarding packaging**

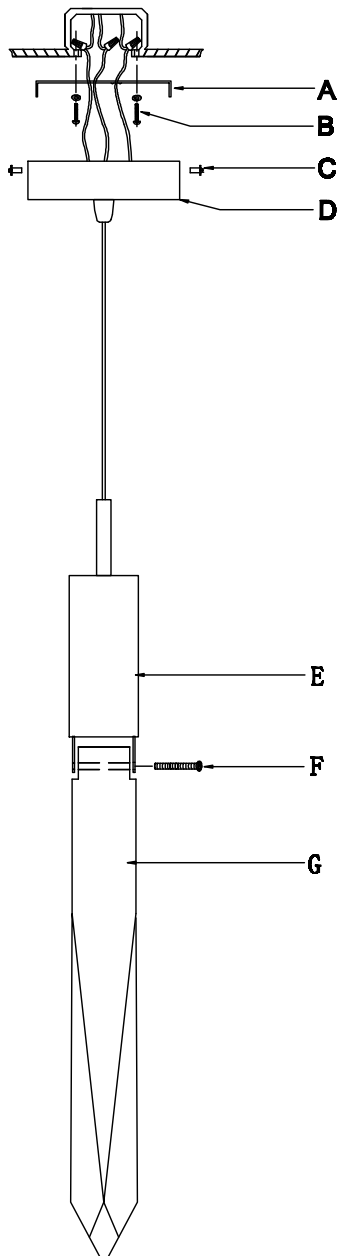

1.)

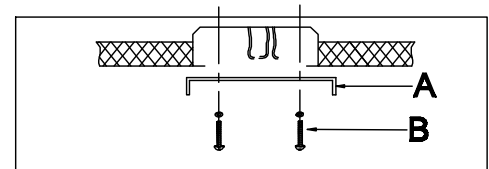

**Step 1: Remove mounting bracket (A) from Canopy (D) and install bracket (A) to electrical box by attaching anchors (B).**

2.)

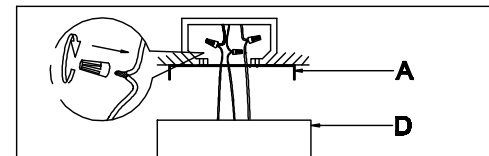

**Step 2: Wire fixture to wires in outlet box. Copper wire is for Ground.**

3.)

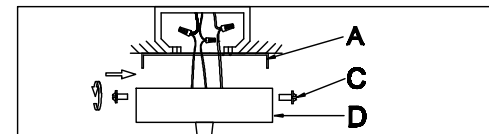

**Step 3: Carefully remove packaging from fixture, Adjust wire length to desired mounting height, Install canopy (D) to bracket using canopy screws (C) on the bottom of the canopy.**

4.)

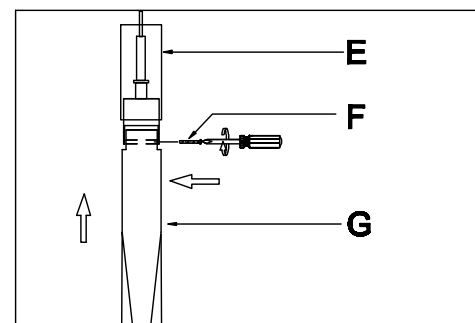

**Step 4: Attach glass (G) using set screws (F).**

**Cleaning & Care:**

Clean with soft cloth and a mild detergent.  
Do not use abrasive cleaner.