

# Contemporary Lighting

**PRODUCT NAME:** Ringer  
**ITEM NUMBER:** E24725-BKPC

**Please consult your electrician for hanging fixture and wiring.**

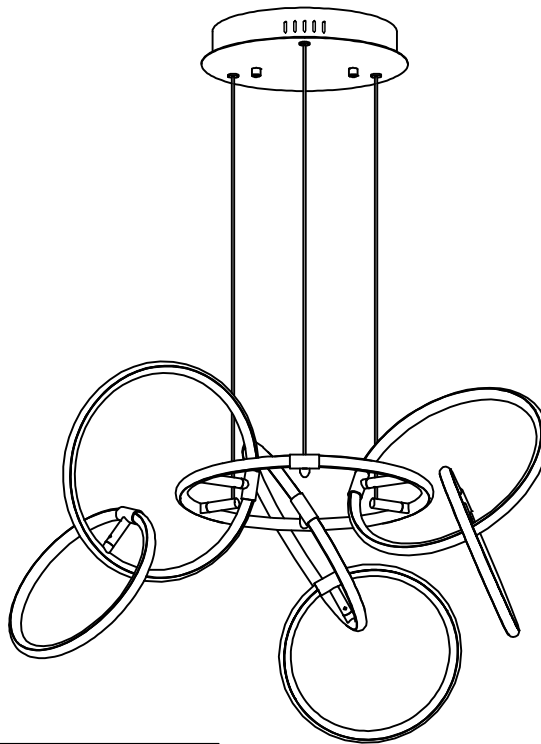

**The fixture is designed to dim with a standard Triac forward phase dimmer. Dimming levels will vary by dimmer.**

**Below is a list of recommended dimmers:**

- Lutron MACL-153M
- Lutron DVL-153P
- Lutron SCL-153P
- Leviton IPL06-10Z
- Leviton 6674-POW

**Due to inrush current wattage should not exceed 150 watts of product for a 600 watt dimmer.**

**Warning! Wires need to be connected to driver found in canopy and should not be connected directly to power source or a short may occur.**

**Bulb (included): LED 81W**

**IMPORTANT: Turn off the power at the main fuse or circuit breaker box before starting installation**



(A)  
Mounting Bracket



(C)  
Finial

**Locate all hardware & components before discarding packaging**

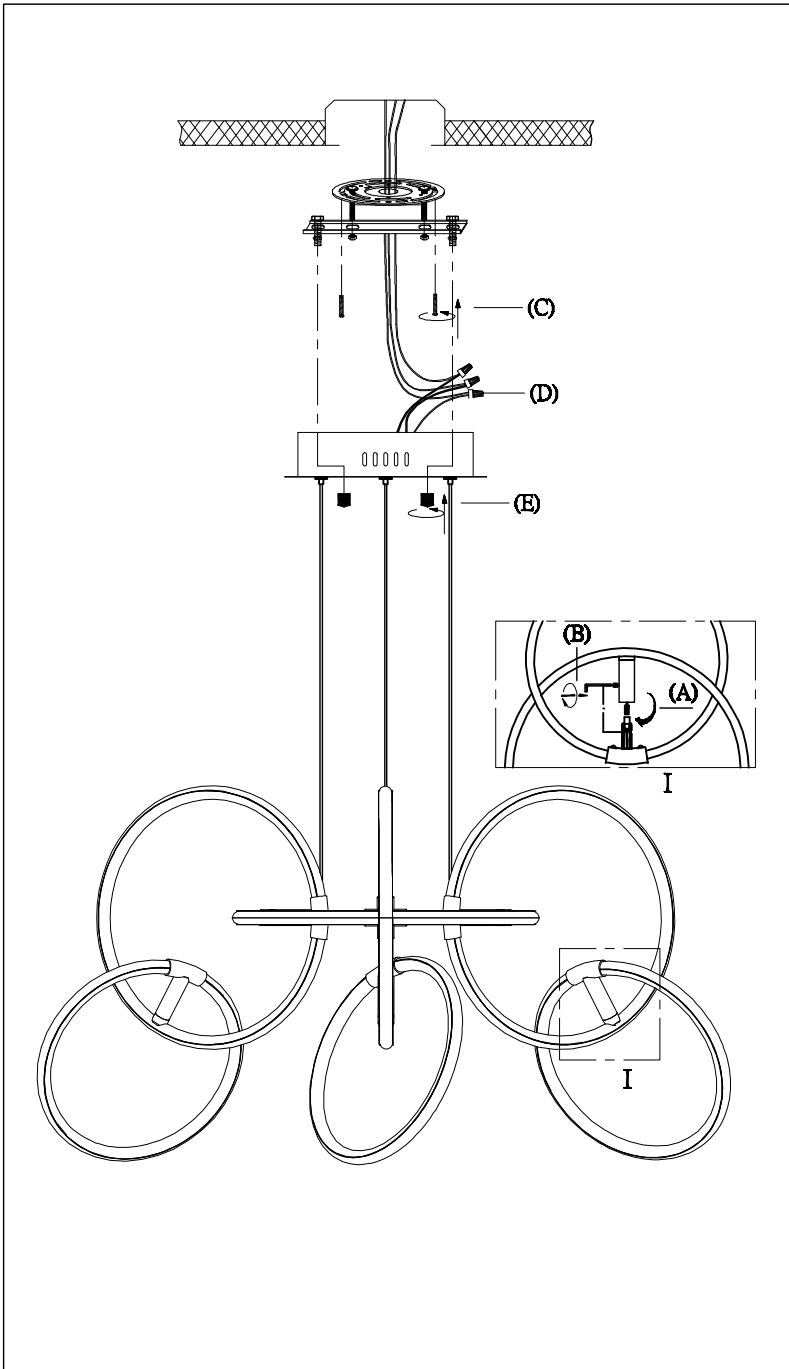

1.)

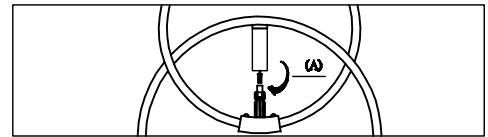

Step.1: Connect outer ring using LED quick connect plug (A).

2.)

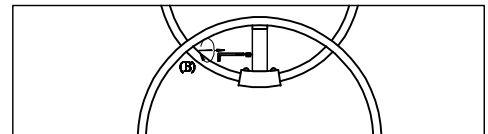

Step.2: Secure ring to fixture using Allen screw tool (B) provided.

3.)

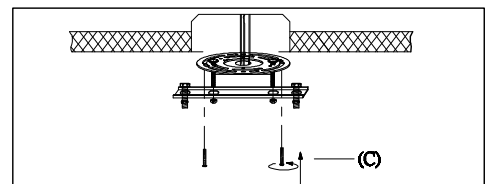

Step.3: Remove mounting bracket (C) from fixture and install to electrical box.

4.)

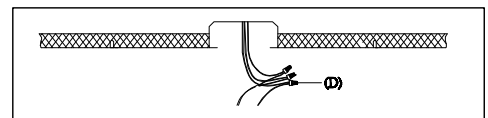

Step.4: Wire fixture to wires (D) in outlet box. Copper wire is for Ground.

5.)

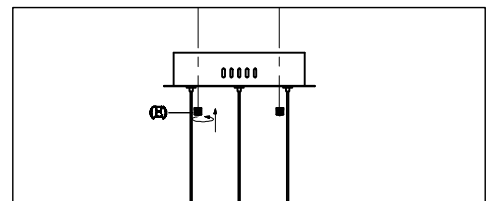

Step.5: Adjust wire length to desired mounting height, and tighten strain relief screws to secure. Install fixture to bracket and tighten screws (E) at the ends of the canopy to secure.

**Cleaning & Care:**

Clean with soft cloth and a mild detergent.  
Do not use abrasive cleaner.