

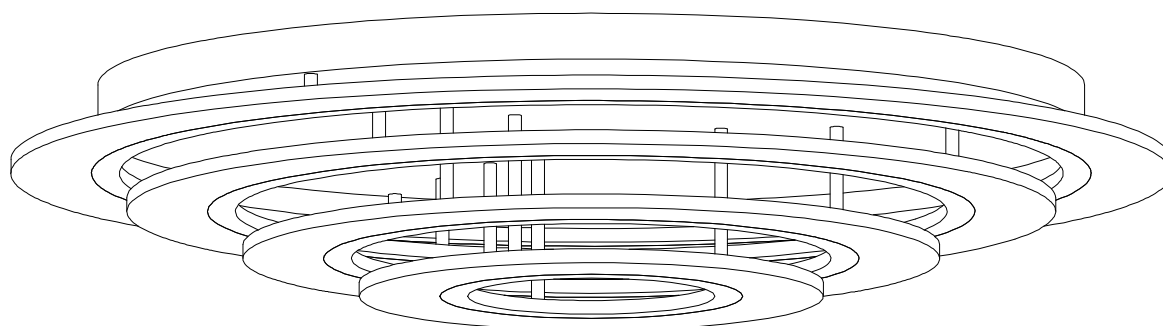





**PRODUCT NAME: Saturu II LED 4-Light Flush Mount**  
**ITEM NUMBER: E22668-11MS**





**Please consult a qualified electrician for hanging fixture and wiring.**

**Light Source : LED Integrated 159W**

**Made in China / Hecho en China / Fabrique en China**

<b>Before Getting Started</b>	<b>Antes de comenzar</b>	<b>Avant de commencer</b>
Read the instructions carefully prior to assembling the product.	Lire atentamente las instrucciones antes de ensamblar el producto.	Les attentamente les instructions avant de assembler le produit.
When you open the package with a sharp tool like scutter knife, be careful not to damage the components inside.	Loraque vous ouvrez le paquet avec un outil pointu comme un couteau de coupe, veillez à ne pas endommager les composants à l'intérieur.	Cuando abra el paquete con una herramienta afilada como un cuchillo de corte, tenga cuidado de no dañar los componentes dentro.
Carefully remove all packaging materials and retain for future use.	Retire con cuidado todos los materiales de embalaje y consérvelos para usarlos en el futuro.	Retirez soigneusement tous les matériaux d'emballage et conservez-les pour un usage ultérieur.
Keep all hardware parts and packaging out of reach of small children.	Conservez toutes les pièces matérielles et les emballages hors de portée des petits enfants.	Mantenga todas las piezas y embalajes de hardware fuera del alcance de los niños pequeños.
Choose a clean, level, spacious assembly area. Avoid hard surfaces that may damage the product.	Choisissez une zone d'assemblage propre, de niveau et spacieuse. Évitez les surfaces dures qui pourraient endommager le produit.	Elija una zona de ensamblaje limpia, nivelada y espaciosa. Evite superficies duras que puedan dañar el producto.
Ensure that you have all required contents for complete assembly.	Assurez-vous que vous avez tous les contenus requis pour l'assemblage complet.	Assurez-vous de que vous avez tous les contenus nécessaires pour l'assemblage complet.
Take care when lifting. Assemble the product in close proximity to where you intend to position the item.	Prenez soin de soulever. Assemblez le produit à proximité de l'endroit où vous comptez positionner l'élément.	Tenga cuidado al levantar. Ensamble el producto cerca de donde tiene la intención de posicionar el artículo.
Do not over tighten the screws and bolts as this may damage the threads.	Ne serrez pas trop les vis et les boulons car cela pourrait endommager les filets.	No apriete excesivamente los tornillos y pernos, ya que esto puede dañar los hilos.
Do not let children play with this product.	No permita que los niños jueguen con este producto.	Né laissez pas les enfants jouer avec ce produit.
 <b>Risk of suffocation!</b> Keep any packaging materials away from children.	 <b>Riesgo de asfixicación!</b> Mantenga los materiales de embalaje lejos de los niños.	 <b>Risque d'asphyxie!</b> Tenez tous les matériaux d'emballage à l'écart des enfants.

<b>Lamp Care Instructions</b>	<b>Instrucciones de lámparas</b>	<b>Entretien de la lampe</b>
Carefully read through the instruction sheet before assembly and using the product.	Lea cuidadosamente la hoja de instrucciones (si fue proporcionada) antes de armar/utilizar la lámpara.	Avant de procéder à l'assemblage et à l'utilisation de la lampe, lisez attentivement le mode d'emploi.
Caution there is a risk of shock. Disconnect from power source before assembling or cleaning.	Peligro por descarga eléctrica. Desconecte la lámpara de la fuente de electricidad antes de armarla o limpiarla.	Pour éviter tout risque d'électrocution, débranchez la lampe de la prise électrique avant de procéder à l'assemblage ou au nettoyage de la lampe.
 <b>WARNING:</b> Wires need to be connected to driver found in canopy and should not be connected directly to power source or a short may occur.	 <b>ADVERTENCIA:</b> los cables deben estar conectados al conductor que se encuentra en el dosel y no deben conectarse directamente a la fuente de alimentación o se puede producir un cortocircuito.	 <b>AVERTISSEMENT:</b> Nécessité de câbles à connecter au pilote trouvé dans la canopée et ne doit pas être connecté directement à la source d'alimentation ou un court-circuit peut se produire.
Only use the recommended bulb type and do not exceed the maximum wattage as it could cause fire.	Solo utilice el tipo de bombilla recomendado y no exceda la potencia eléctrica máxima ya que puede causar un incendio.	Afin d'éviter tout risque de feu, utilisez le type et la puissance d'ampoule recommandés.
Do not plug the product in if cord is torn or frayed.	No conecte la lámpara si el cable eléctrico está dañado o deshilachado.	Ne branchez pas la lampe si son cordon d'alimentation est déchiré ou effiloché.





<b>Cleaning &amp; Maintenance</b>	<b>Limpieza y mantenimiento</b>	<b>Nettoyage et maintenance</b>
On polished finishes, often using talc powder reduces the appearance of fingerprints and other smudges.	En acabados pulidos, a menudo usando polvo de talco reduce la aparición de huellas dactilares y otras manchas.	Sur les finitions polies, souvent en utilisant la poudre de talc réduit l'apparence des empreintes digitales et d'autres taches.
For respective shade surfaces, use the appropriate cleansers, i.e. glass cleaner, acrylic polish, and wood polish.	Para las respectivas superficies de sombra, utilice los limpiadores apropiados, es decir, limpiador de vidrio, esmalte acrílico y pulido de madera.	Pour les surfaces d'ombrage respectives, utilisez les nettoyants appropriés, c'est-à-dire le nettoyant pour vitres, le Vernis acrylique et le vernis à bois.
Clean with soft cloth and a mild detergent. DO NOT use abrasive cleaner.	Utilice un trapo limpio, suave y seco que no raye ni manche la superficie cuando quite el polvo.	Nettoyer avec un chiffon doux et un détergent doux. N'utilisez pas de nettoyant abrasif.
Periodically (every 90 days) make sure that the screws are fully tightened.	Períodicamente (cada 90 días) asegúrese de que los tornillos estén bien apretados.	Périodiquement (tous les 90 jours), assurez-vous que les vis sont bien serrées.
Prolonged exposure to heat source may cause glazing, melting and scorching, or even cause color to fade.	La exposición prolongada a las fuentes de calor causa cristalización, derretimiento, quemadura y decoloración del tapizado.	Si les exposez à une exposition prolongée aux sources de chaleur, il pourrait commencer à reuire, à roussir, à s'estomper ou même à se décolorer.

# EN Contents

Before getting started, ensure the package contains the following components:

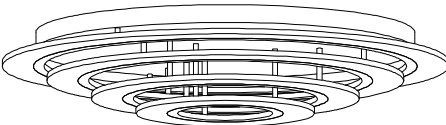
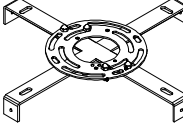
Antes de comenzar, asegúrese de que el paquete contenga los siguientes componentes:

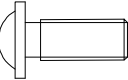
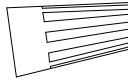
Avant de commencer, assurez-vous que le paquet contient les composants suivants:

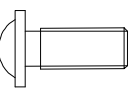
<b>A</b>	 <b>FIXTURE</b>	<b>x1</b>		
<b>B</b>	 <b>MOUNTING BRACKET</b>	<b>x1</b>		
<b>C</b>	 <b>SCREW</b>	<b>x8</b>		
<b>D</b>	 <b>HANGING PLATE SCREWS</b>	<b>x4</b>		
<b>E</b>	 <b>WIRE NUTS</b>	<b>x3</b>		
<b>F</b>	 <b>white glove</b>	<b>x2</b>		
<b>G</b>	 <b>MOUNTING SCREWS</b>	<b>x2</b>		

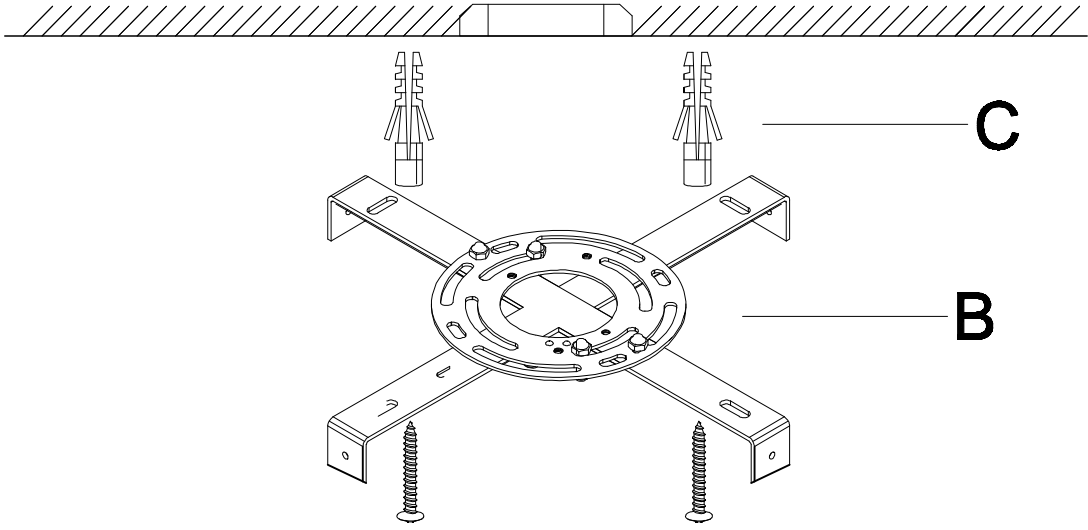

1.

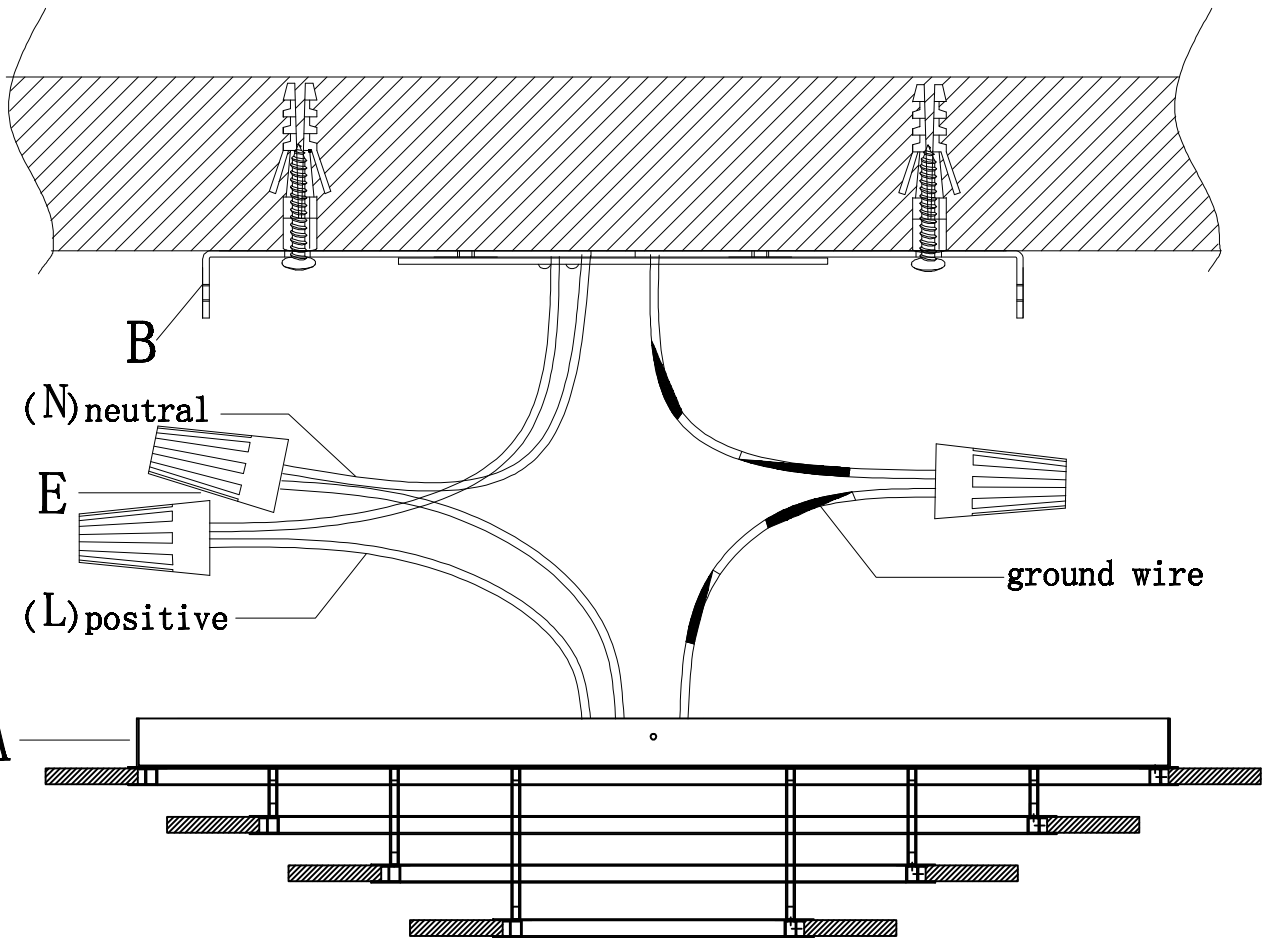

2.

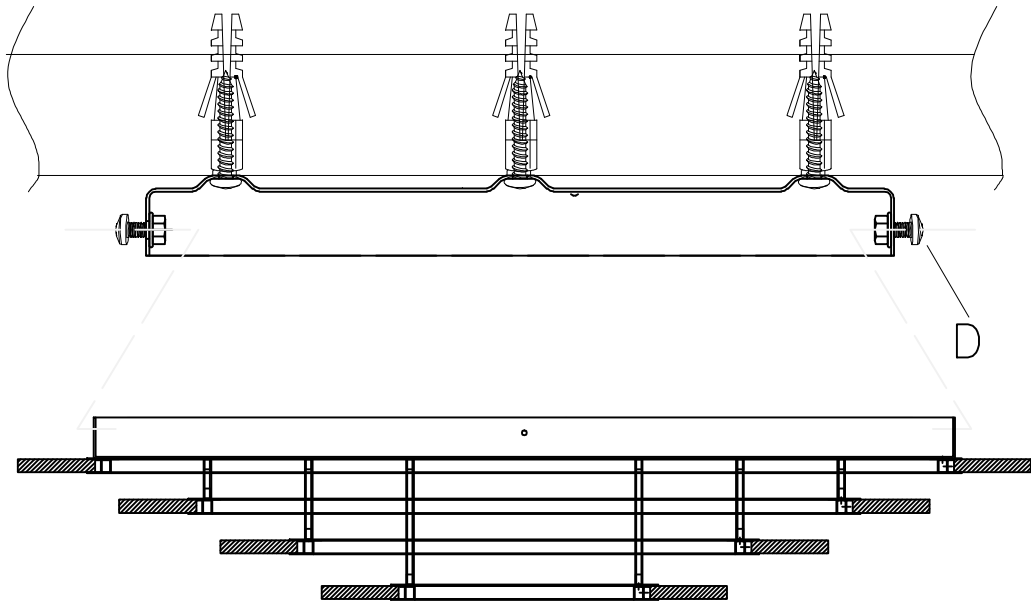

3.

---

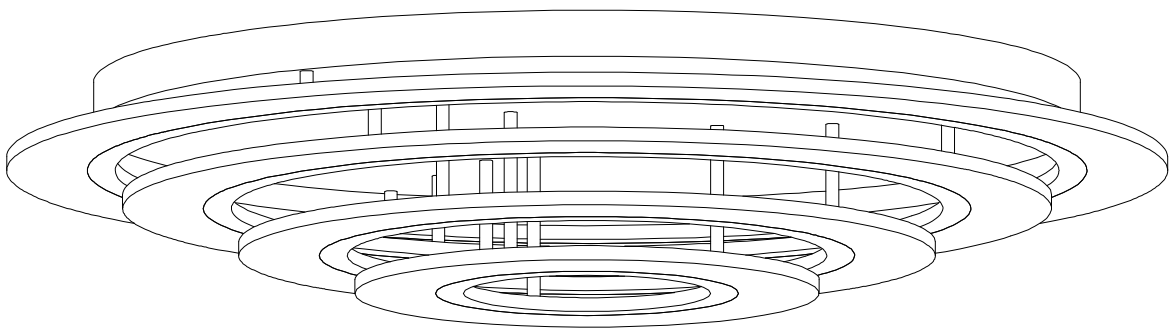

4.

---

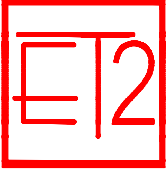

# CRITICAL INSTRUCTION

DVELV Dimmers

be installed with compatible dimmer types only.  
Improper wiring of fixture and/or use of incorrect dimmers will  
and void the warranty.

## E22668-11MS

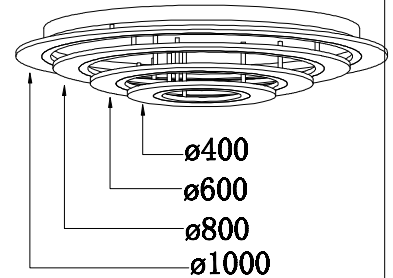
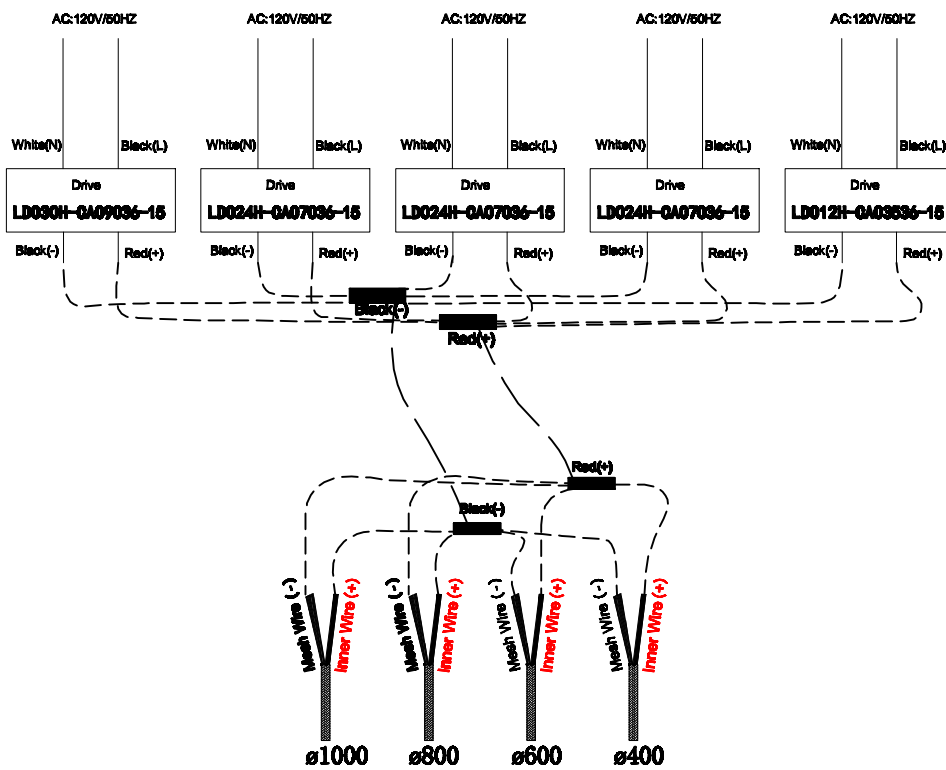

### SCHEMATIC FOR GENERAL REFERENCE ONLY

if fixture does not light,  
reverse polarity.

#### FOR OPTIMAL USE

Lutron DVELV-300P

#### DO NOT USE

Lutron PD-5NE  
Lutron CTCL-150H-WH  
Leviton DSL06

#### IMPORTANT

Make sure that your  
dim mable LED fixture is paired  
with the correct dimmer type

Must be installed by a licensed electrician with  
knowledge of electronic lighting systems

# ATTENTION

## THIS FIXTURE USES A BRAIDED COAXIAL POWER CORD

### CENTER CONDUCTOR

The main signal path. Can be solid or stranded wire.

### DIELECTRIC

Insulating material isolates shield from center conductor. This also gives the cable its impedance properly.



### JACKET

Insulates and protects shielding and center conductors.

### BRAID

One of the two conductors in coaxial cable. Braid or braid plus foil is typical.

It consists of an inner stranded conductor and outer braided conductor. The ends have been precisely stripped and split at the factory.

- **This cord must not be field cut**  
Excess cord or cable should be neatly coiled and reserved in the fixture canopy.
- **Do not open factory connections**

**MODIFYING THIS CORD WILL VOID THE WARRANTY**

© 2019 MAXIMGROUPCO

**MAXIM**<sup>®</sup>  
GROUP • COMPANIES