

Contemporary Lighting

PRODUCT NAME: Alumilux
ITEM NUMBER: E41493

Please consult your electrician for hanging fixture and wiring.

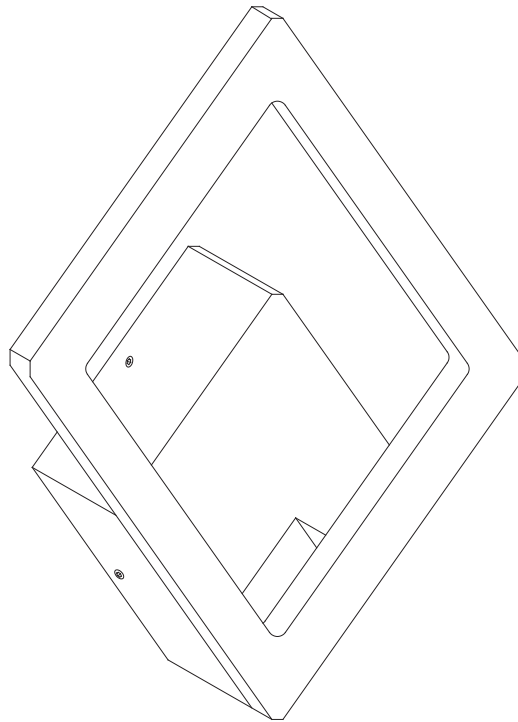

The fixture is designed to dim with a standard Triac forward phase dimmer. Dimming levels will vary by dimmer.

Below is a list of recommended dimmers:

- Lutron MACL-153M
- Lutron DVL-153P
- Lutron SCL-153P
- Leviton IPL06-10Z
- Leviton 6674-POW

Due to inrush current wattage should not exceed 150 watts of product for a 600 watt dimmer.

WARNING: Wires need to be connected to driver found in canopy and should not be connected directly to power source or a short may occur.

WARNING: Wires need to be connected to driver found in canopy and should not be connected directly to power source or a short may occur.

To prevent water intrusion, caulk around back-plate where fixture meets the wall using outdoor silicone sealant. Leave a small gap at the bottom to allow moisture to exit.

LED 21W

IMPORTANT: Turn off the power at the main fuse or circuit breaker box before starting installation



(A)

Mounting bracket

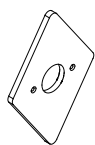

(B)

Backplate



(C)

Wire Nuts (x3)



(D)

Mounting screws (x4)

Locate all hardware & components before discarding packaging

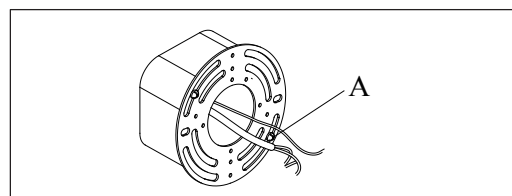
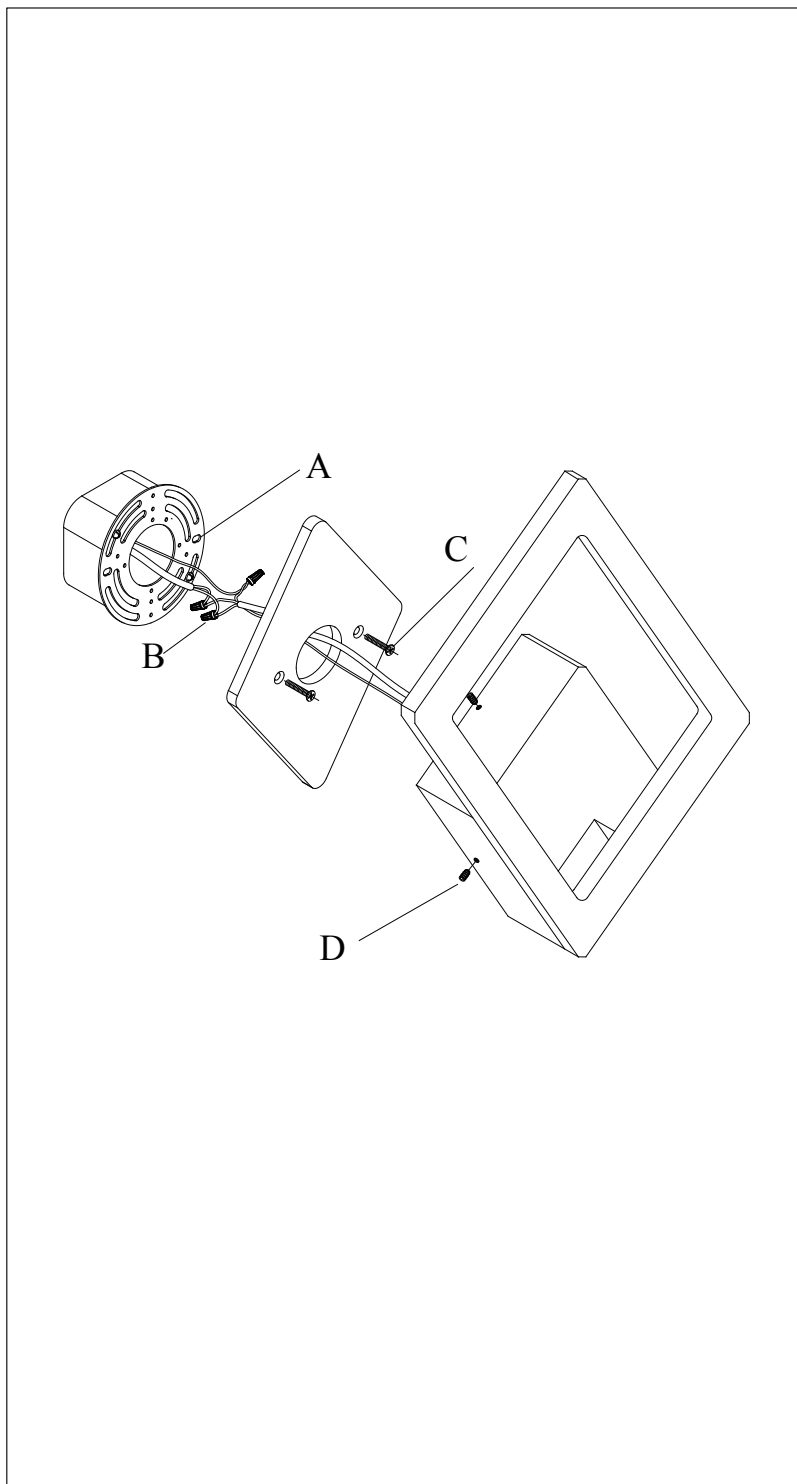

1.)

Step.1: Install Mounting bracket(A) to outlet box.

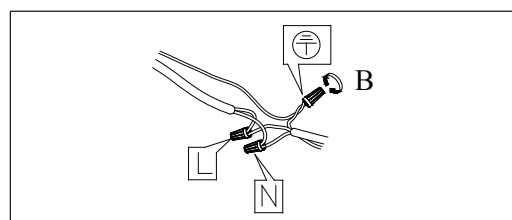

2.)

Step.2: Wire fixture to wires in outlet box.
Green/Copper wire is for Ground.

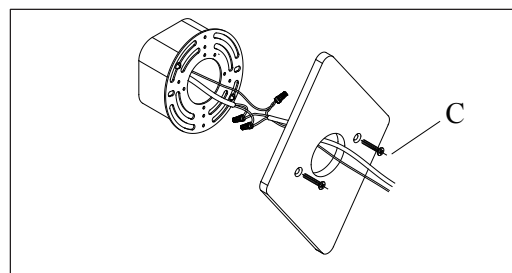

3.)

Step.3: Install Backplate(B) to Mounting bracket(A).

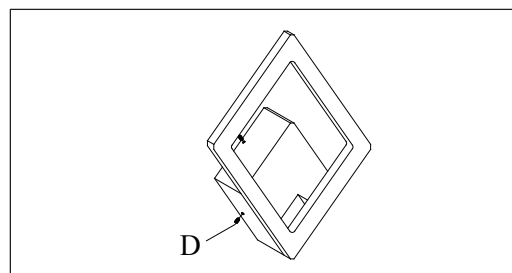

4.)

Step.4: Caulk around fixture with outdoor silicone sealant to prevent water intrusion. Leave a small gap at the bottom to allow moisture to escape. Install fixture to back plate (B) and tighten mounting screws (D) to secure.

Cleaning & Care:

Clean with soft cloth and a mild detergent.
Do not use abrasive cleaner.